



# 04

## Fresas e porta-lâminas de união e macho-fêmea

Fresas y cabezales para juntas  
y machihembrados perfilados



araújo&silva  
ferramentas de corte

# JÁ MEDIU A SUA PRODUTIVIDADE?



A Araujo&Silva, Lda. desenvolve ferramentas especiais, proporcionando aos seus clientes as soluções mais rentáveis.



araújo&silva  
ferramentas de corte

ESPECIALISTAS EM FERRAMENTA DE CORTE

[www.araujosilva.pt](http://www.araujosilva.pt)



HW · MAN

D	B	d	Z	V	T max	n min · n max	Ref.
160	100	50	3			4800 - 8300	7100.301



ACESSÓRIOS - Piezas de recambio

	dim.	Nr.	Ref.
Lâmina	50x25x2	1	7100.01
	50x25x2	2	7100.02
Calço			5105.007
Perno	M8x16		5302.103
Anilha	80x6.5		7100.03

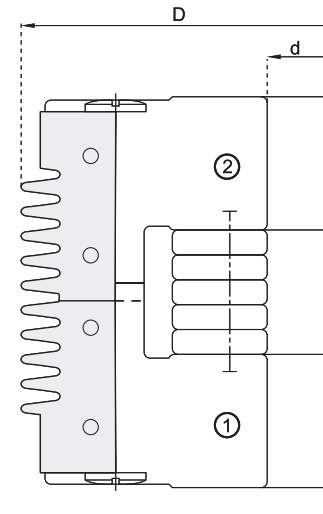
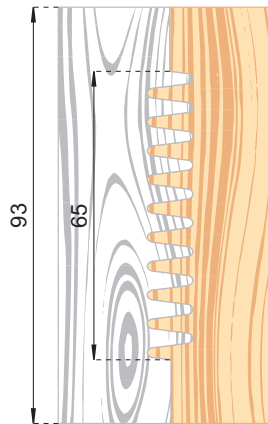
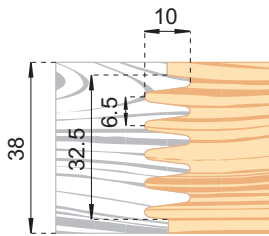

Fresa para união de madeira  
Fresa para unirse a la madera

HW · MAN

Nr.	D	B	d	Z	n min · n max	Ref.
1	140	30	50	3	5500-9000	1300.201
2		40	50	3	5500-9000	1300.202
3		70	50	3	5500-9000	1300.203

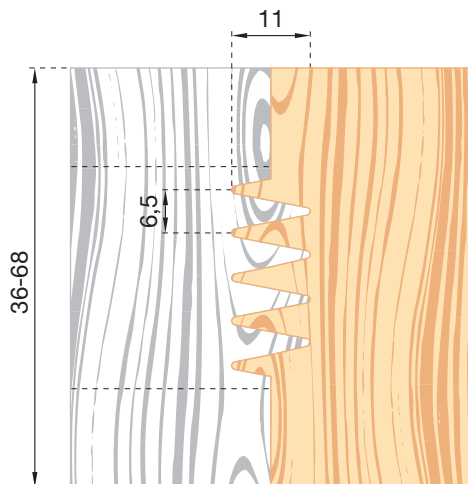

Nr. 3

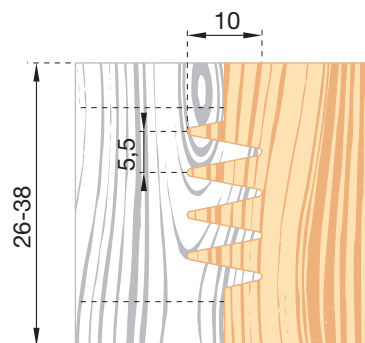

Nr. 2

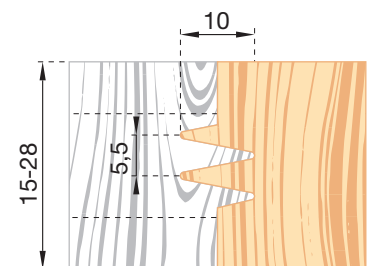

Nr. 1



## 2375 Porta-lâminas para união de madeira Cabezal para ensamblar

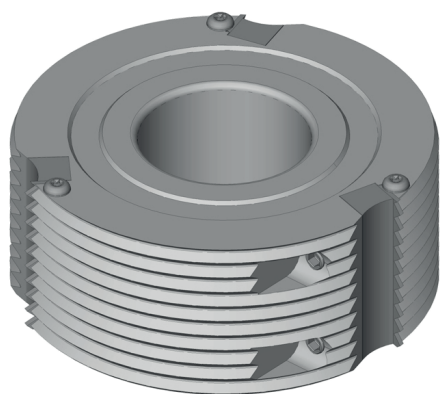

HM · MAN

Nr.	D	B	d	Z	n min - n max	Ref.
1	125	50	50	2	6000 - 10000	2375.125
1		50	50	3	6000 - 10000	2375.126
2		80	50	3	6000 - 10000	2375.127
3		50	50	3	6000 - 10000	2375.128
4		80	50	2+2	6000 - 10000	2375.129

### ACESSÓRIOS - Peças de recambio

	Nr.	Dim.	Ref.
Lâmina	1	50x12x1,5	5203.50.12.1
	2	80x13x2,2	5203.80.13.1
	3	50x22x2	5203.50.22.1
	4	80x20x2	5203.80.20.2
Calço	1		5418.001
	2		5426.001
	3		5427.001
	4		5400.078
Perno (DIN915)	1/2	M8x12	5105.006
	3/4	M8x16	5105.107
Chave em T		SW4	5302.103
Anilha	1/2	70x2,17	5075.852
	4	70x2,5	5075.851

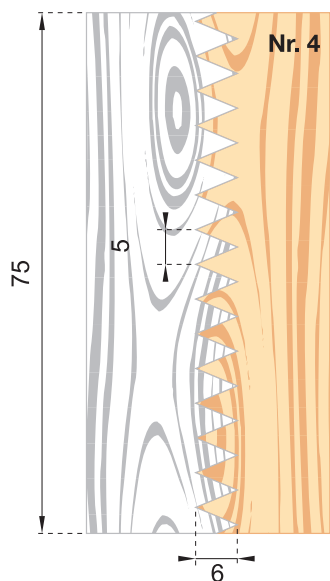
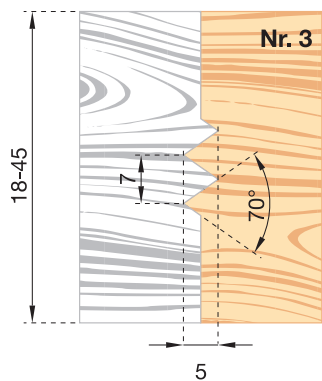
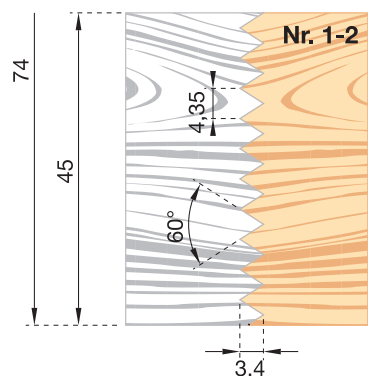



HW · MAN

Nr.	D	B	d	Z	n max	HW Ref.
1	120	48,5	30	2	10000	1303.101
1	140	48,5	50	3	9000	1303.201
2		88,5	50	3	9000	1303.202
3		50	50	3	9000	1303.203
4		60	50	4	9000	1303.204

ACESSÓRIOS - Piezas de recambio

Nr.	Dim.	Ref.
Anilha	1/2/4	70x2,5

Nr. 1/2/4  
UNIÃO PERFEITA DA MADEIRA AJUSTÁVEL POR ANILHA  
Junta perfecta del material por anillo.

Nr. 3  
UNIÃO PERFEITA DA MADEIRA POR REGULAÇÃO DO PERFIL AO CENTRO DA ALTURA DA MADEIRA.  
Junta perfecta del material por regulacion del perfil a la mitad de la altura de la madera.

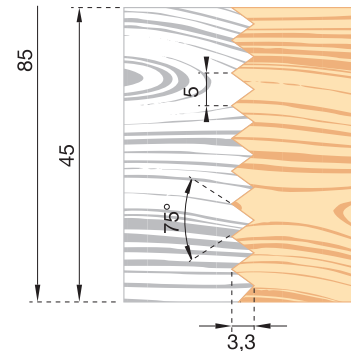

Nr. 1-2

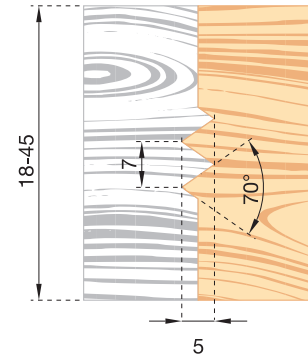

Nr. 3

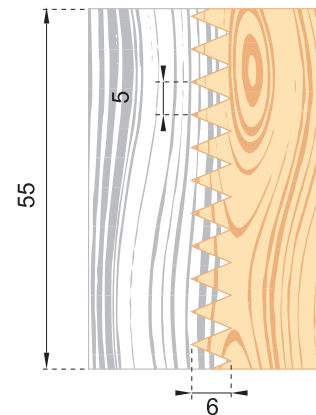

Nr. 4



## 2376 Porta-lâminas para união de madeira longitudinal Cabezal para juntas longitudinais



HM · MAN

Nr.	D	B	d	Z	n min - n max	Ref.
1	140	50	50	2	5500 - 9600	2376.201
2		60	50	2	5500 - 9600	2376.202

ACESSÓRIOS - Peças de recambio

	Dim.	B	Ref.
Lâmina	50x22x2		5030.01
	60x22x2		5030.02
Calço		50	5427.001
		60	5426.001
Perno (DIN915)	M8x16		5105.007
Chave em T	SW4		5302.103

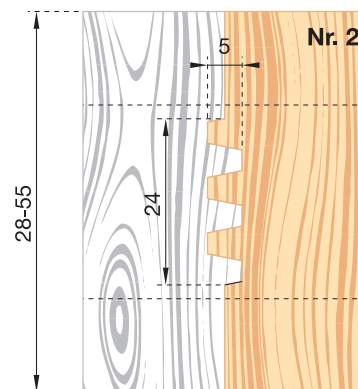
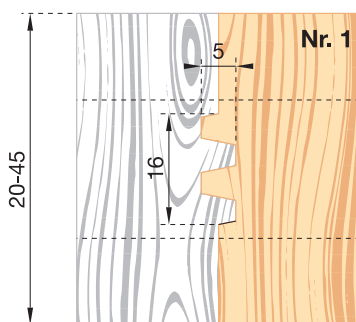

## 1304 Fresa para união de madeira longitudinal Fresa para juntas longitudinais



HM · MAN

D	B	d	Z	n min - n max	Ref.
140	50	50	3	5500 - 9500	1304.201
	60	50	3	500-9500	1304.202

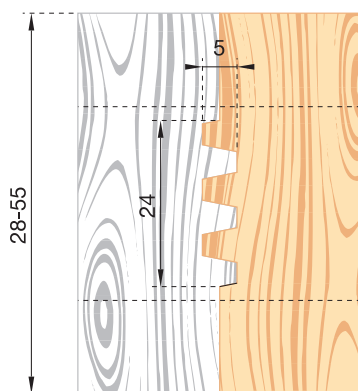

Nr. 2

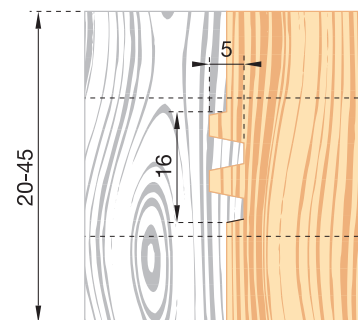

Nr. 1





HM · MAN

D	B	d	Z	I	n min · n max	HW Ref.
180	50	2	2		4300 - 7400	2400.201
180	50	3	3		4300 - 7400	2400.202

**ACESSÓRIOS - Peças de recambio**

Dim.	Ref.
Lâmina 50x12x1,5	5032.01
Calço	5429.001
Perno (DIN915) M8x16	5105.007
Ranhurador 24,6x13x4	5028.01
Parafuso M5x13,5	5108.001
Chave em T SW3 (M5)	5302.102
SW4 (M8)	5302.103



**PROJ. 04560 + Foto**

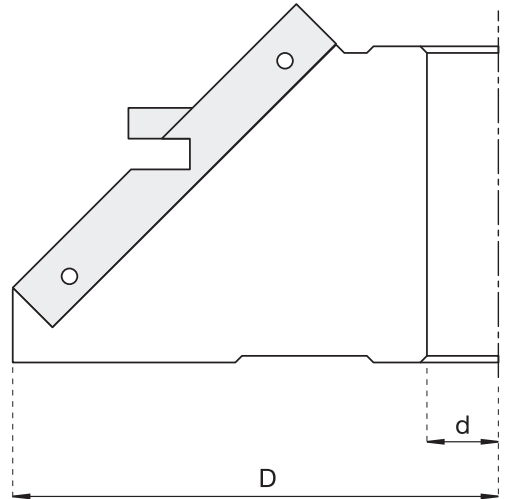
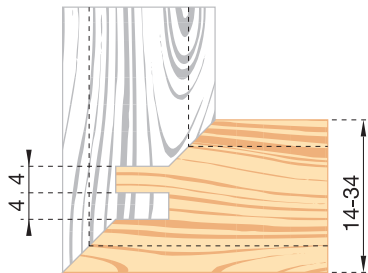

04

Fresas e porta-lâminas de união e macho-fêmea · Fresas e cabezales para juntas e machiembreados perfiliados

**Jogo de fresas para 1/2 esquadria 1130**  
Juego de fresas para juntas 90°

HW · MAN

Nr.	D	B	d	Z	V	n max	HW Ref.
1	180	35	50	3		8300	1130.401
2	153	8	50	3	3	8300	1130.201
1+2							1130.801

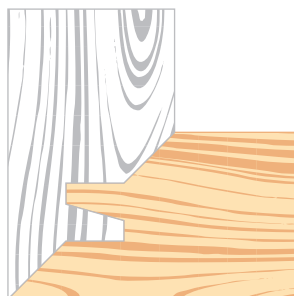
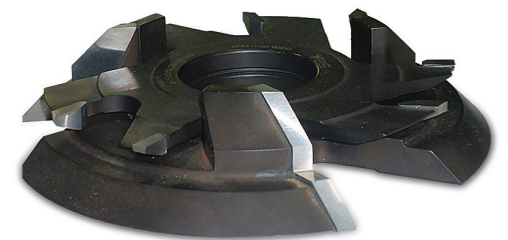



## 2425 Porta-lâminas macho fêmea Cabezal de machihembrar



### HW · MEC

Nr.	D	B	d	Z	V	C	l	n max	Ref.
1	140	15	60	4	2	2		9000	2425.201
2	124	12	60	2				10000	2425.101
3	140	15	60	4	2	2		9000	2425.202
4	140	20	60	4			2	9000	2425.203
5	141	20	60	4			2	9000	2425.204
6	140	20	60	4			2	9000	2425.205
7	154,4	11,6	60	2				8500	2425.251
8	154,4	11,6	60	2				8500	2425.252
9	171	15	60	4	2	2		7500	2425.351
10	159	20	60	4			2	8000	2425.253

A PEDIDO O JOGO SERÁ FORNECIDO MONTADO COM MANGA E ANILHAS DE ENCHIMENTO. Sobre pedido se suministra con tubo y anillos de regulación.

### ACESSÓRIOS - Piezas de recambio

	Nr.	Dim.	Ref.
Lâmina		11,6x12x1,5	5000.06.1
		12x12x1,5	5003.01.1
		15x12x1,5	5000.09.1
		20x12x1,5	5000.12.1
Calço	2/7/8		C2425.01
	1/3/9		C2425.02
	4/5/6/10		C2425.03
Perno (DIN915)	1/2/3/9	M8x16	5105.007
	4/5/6/7/8/10	M8x12	5105.006
Vincador	14x14x2		5002.01.1
Parafuso (DIN963)		M5x8	5107.003
Chanfrador		22x16x5 45°	5026.01
Ranhurador		25x13x4	5028.01
Parafuso		M5x13,5	5108.001
Chave em T		SW3 (M5)	5302.102
		SW4 (M8)	5302.103

### MANGA DE APERTO - tubo

d	L	D	Ref. LH	Ref. RH
40	110	60	5095.23	5095.24
50	110	60	5095.27	5095.28



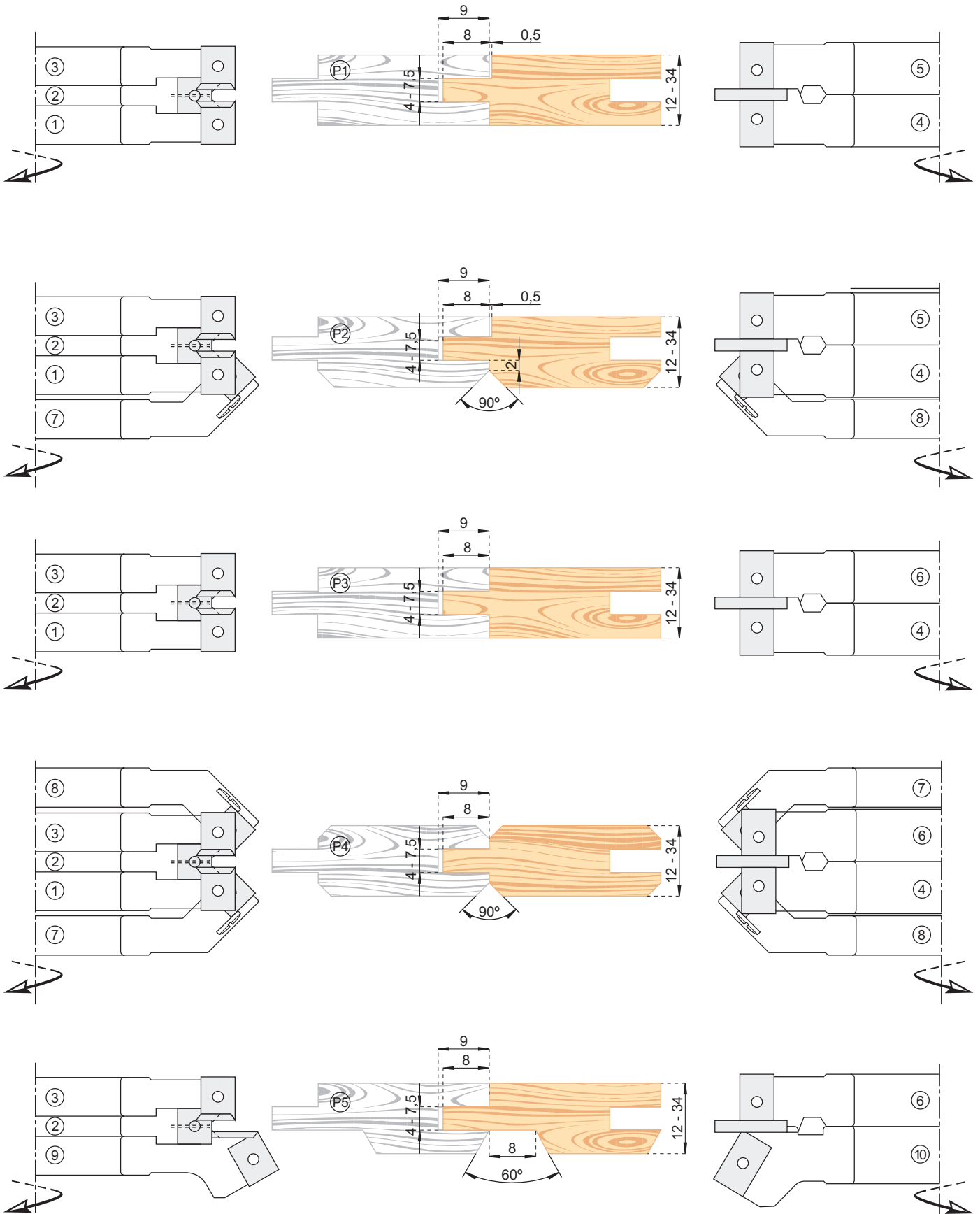



# 7025 Jogo macho-fêmea Juego de machihembrar



LH

RH

HW · MEC

REGULAÇÃO POR ANILHAS.  
Regulación por anillos.

n max 8000

04

Fresas e porta-lâminas de união e macho-fêmea · Fresas y cabezales para juntas y machihembrados perfilados

D	Z	Ref.
---	---	------

160	4	7025.301
160	6	7025.303

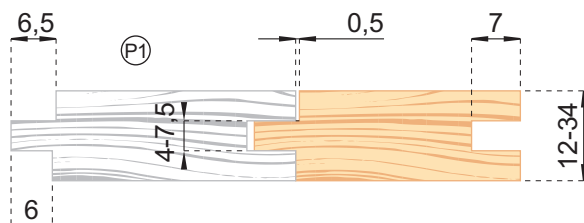

D	Z	Ref.
---	---	------

160	4	7025.302
160	6	7025.304

D	Z	Ref.
---	---	------

160	4	7025.305
160	6	7025.307

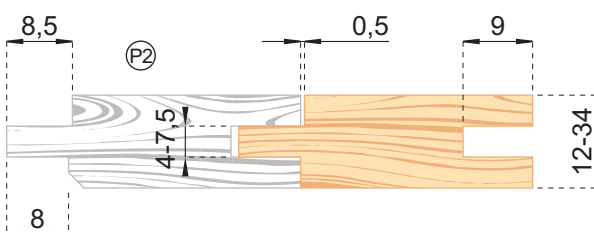

D	Z	Ref.
---	---	------

160	4	7025.306
160	6	7025.308

D	Z	Ref.
---	---	------

160	4	7025.309
160	6	7025.311

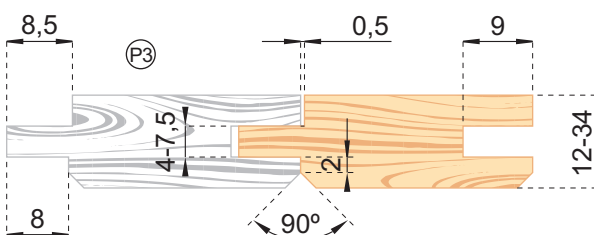

D	Z	Ref.
---	---	------

160	4	7025.310
160	6	7025.312

D	Z	Ref.
---	---	------

160	4	7025.313
160	6	7025.315

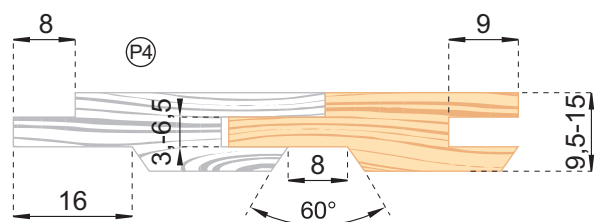

D	Z	Ref.
---	---	------

160	4	7025.314
160	6	7025.316

D	Z	Ref.
---	---	------

160	4	7025.317
160	6	7025.319

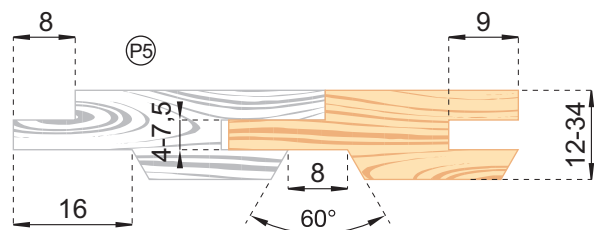

D	Z	Ref.
---	---	------

160	4	7025.318
160	6	7025.320



D	Z	Ref.
160	4	7025.321
160	6	7025.323

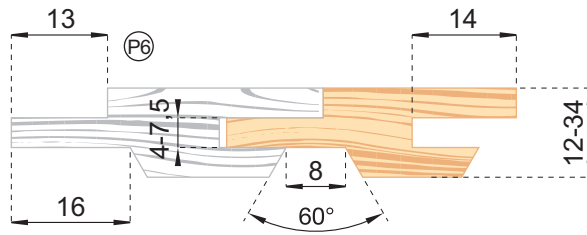

D	Z	Ref.
160	4	7025.322
160	6	7025.324

D	Z	Ref.
		7025.325
160	4	7025.327
160	6	

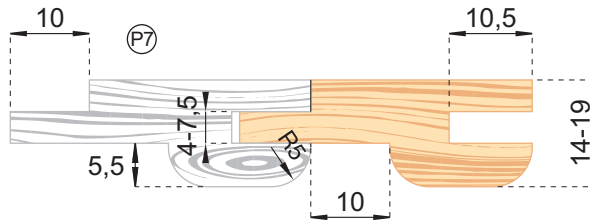

D	Z	Ref.
		7025.326
160	4	7025.328
160	6	

araújo&silva  
ferramentas de corte

[www.araujosilva.pt](http://www.araujosilva.pt)